

Analytic calculation of some NRQCD master integrals

Maxim Bezuglov

Bezuglov, M.A., Kotikov, A.V. & Onishchenko, A.I. On Series and Integral Representations of Some NRQCD Master Integrals. *Jetp Lett.* (2022).

Quantum field theory

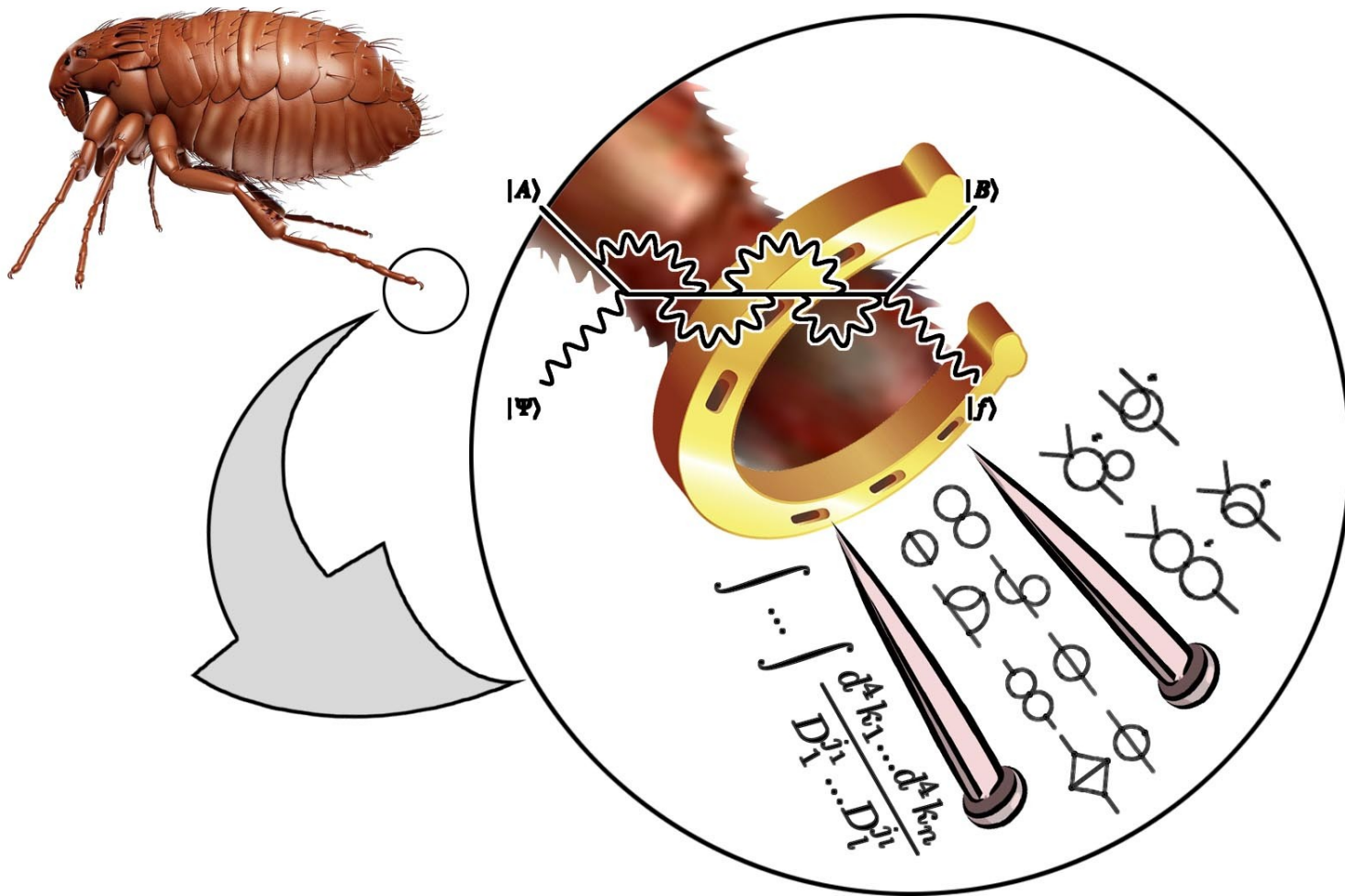

Introduction

Feynman integral:
$$\int \dots \int \frac{d^4 k_1 \dots d^4 k_n}{D_1^{j_1} \dots D_l^{j_l}}, \quad D_r = \sum_{i \geq j \geq 1} A_r^{ij} p_i p_j - m_r^2$$

Integration by Parts (IBP)
$$\int d^d k_1 d^d k_2 \dots \frac{\partial f}{\partial k_i^\mu} = 0$$
 In dimensional regularization

F. V. Tkachov, Phys.Lett.B 100 (1981) 65-68

K.G. Chetyrkin, F.V. Tkachov, Nucl.Phys.B 192 (1981) 159-204

Any integral from a given family can be represented as a linear combination of some limited **basis** of integrals, elements of this basis are called **master integrals**.

Methods for calculating loop integrals

Solving a system of equations for the system of master integrals

- System of difference equations
- **System of differential equations**

Kotikov, A. V., Phys.Lett.B 254 (1991) 158-164

Kotikov, A. V., Phys.Lett.B 267 (1991) 123-127

Kotikov, A. V., Phys.Lett.B 259 (1991) 314-322

Evaluating by direct integration using some parametric representation

- Feynman parametrisation
- Alpha parametrisation
- MB representation
- et al.

$$\frac{d}{dx} \begin{pmatrix} I_1 \\ I_2 \\ \dots \\ I_n \end{pmatrix} = A(x, \varepsilon) \begin{pmatrix} I_1 \\ I_2 \\ \dots \\ I_n \end{pmatrix},$$

«epsilon form»

$$A(x, \varepsilon) = \varepsilon \sum_i \frac{A_i}{x - c_i}, \quad I_j = \sum_k I_j^{(k)} \varepsilon^k$$

J. M. Henn, Physical review letters, vol. 110, no. 25, p. 251601, 2013.

R. N. Lee, JHEP, vol. 04, p. 108, 2015.

Elliptic loop integrals

«Kite» integral

A. Sabry, Nuclear Physics 33, 401 (1962).

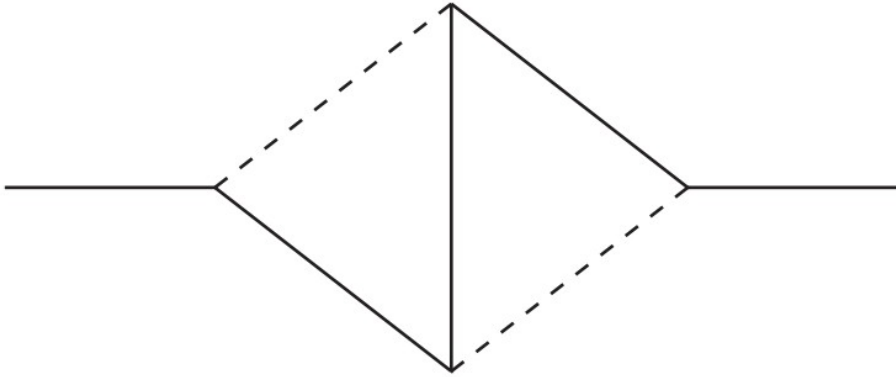

«Sunset» integral

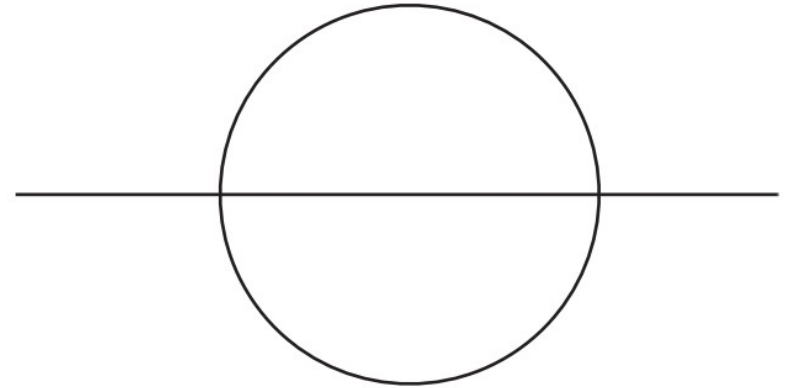

$$\frac{d}{dx} \begin{pmatrix} I_1 \\ I_2 \\ \dots \\ I_n \end{pmatrix} = A(x, \varepsilon) \begin{pmatrix} I_1 \\ I_2 \\ \dots \\ I_n \end{pmatrix},$$

$$A(x, \varepsilon) = \sum_i \frac{A_i(\varepsilon)}{x - c_i},$$

hypothesis:

$$A_i(\varepsilon) = \left(\varepsilon + \frac{1}{2} \right) A_i$$

Lee, R.N. J. High Energ.
Phys. 2018, 176 (2018).

System of integrals describing two-loop corrections to processes in nonrelativistic QCD

$$\gamma\gamma/gg \longrightarrow q\bar{q}$$

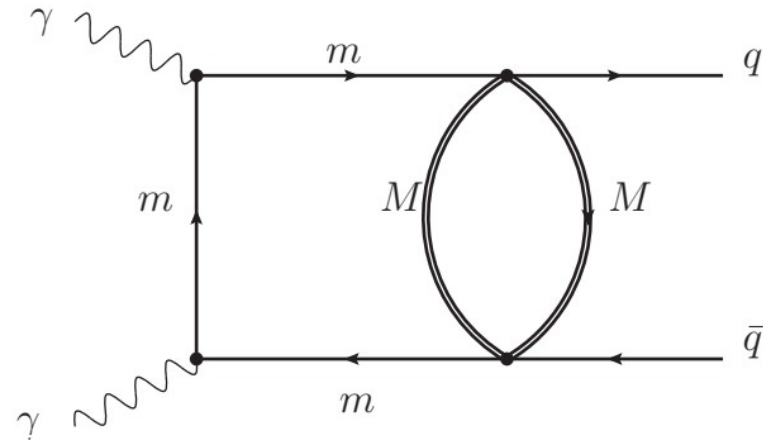
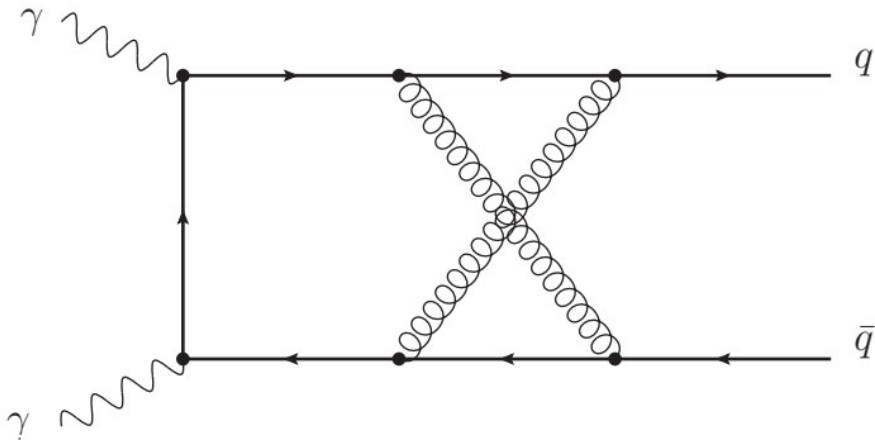

$$x = \frac{m^2}{M^2}$$

$$\int \int \frac{d^d k d^d l}{((l + q_1)^2 - x)^{a_1} ((l - q_2)^2 - x)^{a_2} (l^2 - x)^{a_3} ((k - l)^2 - 1)^{a_4} ((k + q_1/2 - q_2/2)^2 - 1)^{a_5}}$$

**Kniesl, B. A., Kotikov, A. V.,
Onishchenko, A. I., & Veretin, O. L.
Nuclear Physics B, 948, 114780. (2019).**

System of integrals describing two-loop corrections to processes in nonrelativistic QCD

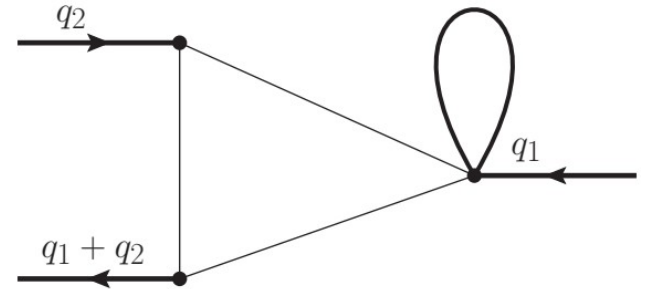
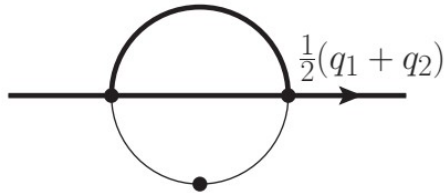
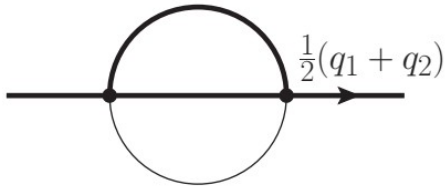
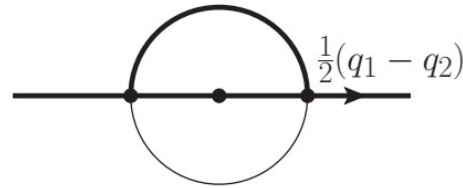
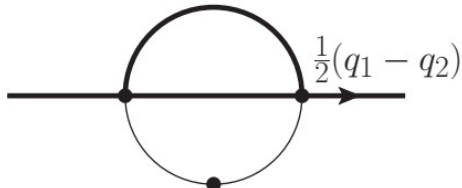
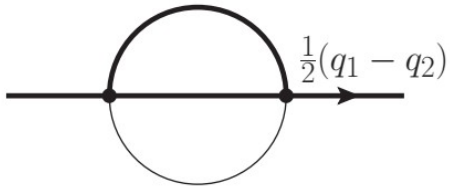
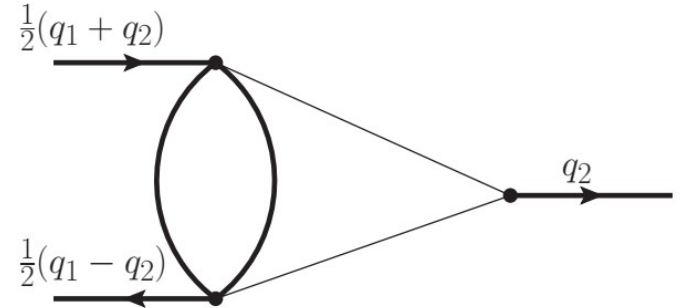
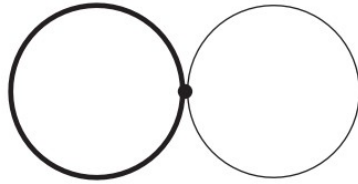
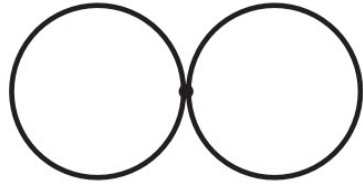

Elliptic sunset

$$J_3 = \text{---} \circlearrowleft \frac{1}{2}(q_1 - q_2)$$

$$(4 + x^2)x^3 \frac{d^3 J_3}{dx^3} + (16 - 2d + 12x^2 - \frac{5d}{2}x^2)x^2 \frac{d^2 J_3}{dx^2} + (3 + d(2 - d) + (d - 4)(2d - 9)x^2)x \frac{dJ_3}{dx} + \frac{1}{2}(11d - 6 - d^2(6 - d) - (d - 4)^2(d - 3x^2))J_3 + \frac{1}{2}(d - 2)^2 J_2 - \frac{1}{4}(d - 2)^2(d - 1 + (d - 3)x)J_1 = 0$$

We will look for solutions in the form: $J_3 = \sum_{n=0}^{\infty} c_n^\lambda x^{2n+\lambda}$

The solution for the coefficients will be given by **first order** recursion!

$$(d - 3 - 4n - 2\lambda)(d - 1 - 4n - 2\lambda)(d - 2 + 4n + 2\lambda)c_n^\lambda - (d - 4n - 2\lambda)(d - 2 - 2n - \lambda)(d - 1 - 2n - \lambda)c_{n-1}^\lambda = 0$$

and solutions are

$$c_n^\lambda = \frac{(-1)^n}{4^n} \frac{\Gamma(1 - \frac{d}{4} + n + \frac{\lambda}{2})\Gamma(3 - d + 2n + \lambda)}{\Gamma(\frac{5}{2} - \frac{d}{2} + 2n + \lambda)\Gamma(\frac{1}{2} + \frac{d}{4} + n + \frac{\lambda}{2})} C_\lambda, \quad \lambda = 0, 1, \frac{d-2}{2}$$

From the boundary conditions and solutions of the characteristic equation

This method of obtaining exact solutions for Feynman integrals was first proposed in

Bezuglov, M.A., Onishchenko, A.I.
J. High Energ. Phys. 2022, 45 (2022).

Elliptic sunset

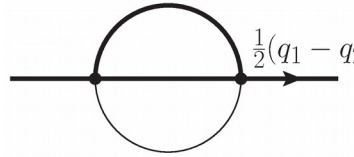

$$= \frac{\pi \csc\left(\frac{\pi d}{2}\right) \Gamma\left(2 - \frac{d}{2}\right)}{\Gamma\left(\frac{d}{2}\right)} \left\{ x^{-1+\frac{d}{2}} {}_4F_3 \left(\begin{matrix} 1, \frac{1}{2}, \frac{4-d}{4}, \frac{6-d}{4} \\ \frac{3}{4}, \frac{5}{4}, \frac{d}{2} \end{matrix} \middle| -\frac{x^2}{4} \right) + \frac{1}{d-3} {}_4F_3 \left(\begin{matrix} 1, \frac{3-d}{4}, \frac{4-d}{4}, \frac{4-d}{4} \\ \frac{5-d}{4}, \frac{7-d}{4}, \frac{2+d}{4} \end{matrix} \middle| -\frac{x^2}{4} \right) \right. \\ \left. + \frac{(d-2)}{d(d-5)} {}_4F_3 \left(\begin{matrix} 1, \frac{4-d}{4}, \frac{5-d}{4}, \frac{6-d}{4} \\ \frac{7-d}{4}, \frac{9-d}{4}, \frac{4+d}{4} \end{matrix} \middle| -\frac{x^2}{4} \right) \right\}$$

Exact solutions for all master integrals can be expressed in terms of **generalized hypergeometric functions**

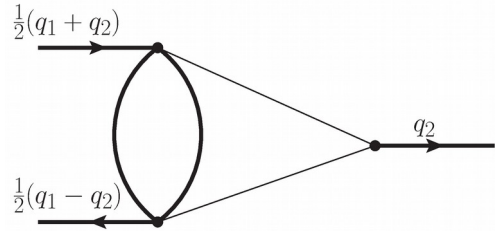

$$= \frac{\pi^2 \csc\left(\frac{\pi d}{2}\right)^2}{\Gamma\left(\frac{d-2}{2}\right)^2} \left\{ \frac{1}{(d-3)(d-4)x} {}_4F_3 \left(\begin{matrix} \frac{1}{2}, 1, 3-d, \frac{4-d}{2} \\ \frac{6-d}{2}, \frac{5-d}{2}, \frac{d-2}{2} \end{matrix} \middle| x \right) - x^{\frac{d}{2}-2} {}_4F_3 \left(\begin{matrix} 1, 1, \frac{4-d}{2}, \frac{d-1}{2} \\ 2, \frac{3}{2}, d-2 \end{matrix} \middle| x \right) \right. \\ \left. + \frac{(d-4)x^{-1+\frac{d}{2}}}{12(d-2)} {}_5F_4 \left(\begin{matrix} 1, 1, \frac{3}{2}, \frac{6-d}{4}, \frac{8-d}{4} \\ 2, \frac{5}{4}, \frac{7}{4}, \frac{d}{2} \end{matrix} \middle| -\frac{x^2}{4} \right) - \frac{1}{(d-3)(d-4)x} {}_5F_4 \left(\begin{matrix} 1, \frac{3-d}{4}, \frac{4-d}{4}, \frac{4-d}{4}, \frac{6-d}{4} \\ \frac{8-d}{4}, \frac{5-d}{4}, \frac{7-d}{4}, \frac{d}{4} \end{matrix} \middle| -\frac{x^2}{4} \right) \right. \\ \left. - \frac{(d-4)}{(d-2)(d-5)(d-6)} {}_5F_4 \left(\begin{matrix} 1, \frac{4-d}{4}, \frac{5-d}{4}, \frac{6-d}{4}, \frac{8-d}{4} \\ \frac{10-d}{4}, \frac{7-d}{4}, \frac{9-d}{4}, \frac{2+d}{4} \end{matrix} \middle| -\frac{x^2}{4} \right) \right\}$$

These results are consistent with those previously obtained by other methods.

M.Y. Kalmykov and B.A. Kniehl,
Nucl. Phys. B 809(2009) 365

Conclusions

- A new method was developed for obtaining an exact solution of elliptic Feynman integrals, in terms of the dimensional regularization parameter, based on the solution of differential equations for the complete system of master integrals by the Frobenius method.
- The use of this method made it possible to obtain exact solutions for a system of master integrals describing two-loop corrections to processes in nonrelativistic QCD.
- Solutions are expressed in terms of hypergeometric series

Future plans

- Generalize the developed technique to the case of "more complicated" elliptic integrals

Thank you for your attention!